



3 oz.



5 oz.



8 oz.

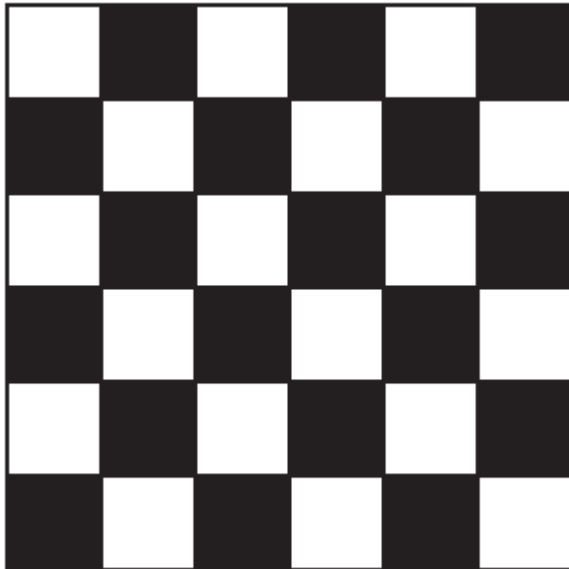

Page 15-16

1. Pile up kittens

2. Run away from Santa's helper

3. Edge of a reflective surface

4. Notice football officials

5. Doctor's assistants move hurriedly

6. Bone in a robin

7. Black-and-white "bear" slept awhile

8. Students make a mistake

9. Stand up before you cast your ballot, mister

-----,

10. Smack friends who join me in exercising



1, 4, 3, 11, 15, 13, 17, 24, __

Page 28 – 29

- **MO__STER.** What two different letters can you put in the blank to make two different common movie bad guys?
- **FINE ARTS.** Can you switch a letter from the first word with a letter from the second word to make a different two-word phrase?
- __ __ **CTARI** __ __. You can put the same pair of letters in both sets of blanks to make a food. Now can you do it with __ __ **MA** __ __? How about __ __ **I** __ __?
- What word becomes its own opposite when you put **FE** in front of it?
- You can add a letter to the word **SCENT**, scramble all the letters, and you'll have another word that means "odor." What is this second word?
- What musical instrument is hiding in the word **COLLECTIVE**?
- What word that means "cold" sounds like a food that's often quite hot?
- What three-letter word meaning "a light touch," when spelled backward, gives you another word meaning "a light touch"?
- Which of the fifty United States contains the word **WHAM**?

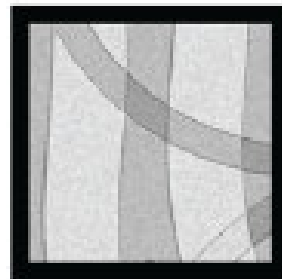
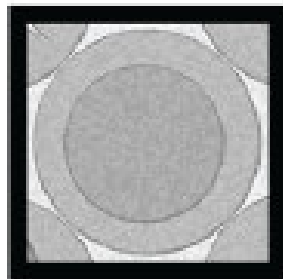
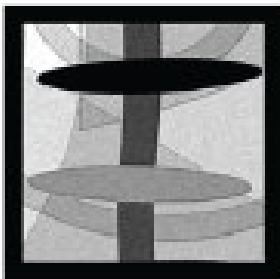
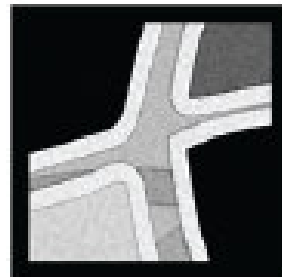
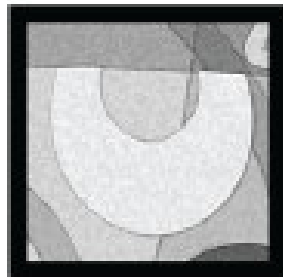
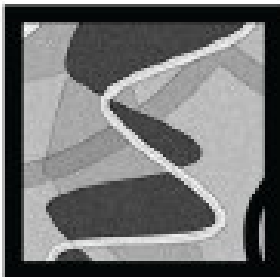

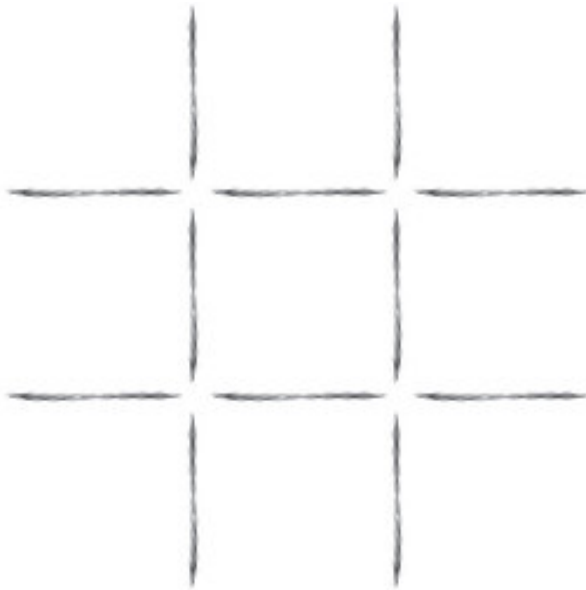

4	4	4	3	5	2
3	2	2	4	4	3
3	1	2	2	4	5
5	3	3	2	4	5
3	1	4	1	1	3
2	2	3	4	5	F

Page 61

OATMEAL
CHEESE
SAUSAGE

MILK
BAGELS
WAFFLES

EGGS
ORANGES
PUDDING

BACON
TOAST
APPLES

YOGURT
GRAPEFRUIT
RAISINS

Page 75

ELLA ENCHANTED
ALL THAT JAZZ
THE BRIDGES OF MADISON COUNTY
MAMMA MIA!
AVATAR
MR. SMITH GOES TO WASHINGTON
THE TRUMAN SHOW
DOCTOR DOLITTLE
GATTACA
ROB ROY
MILDRED PIERCE
CASABLANCA

STAR WARS
ARTHUR
KING KONG

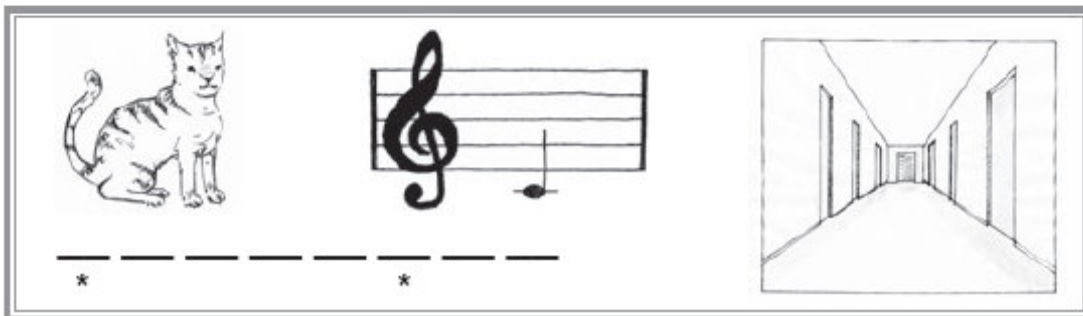
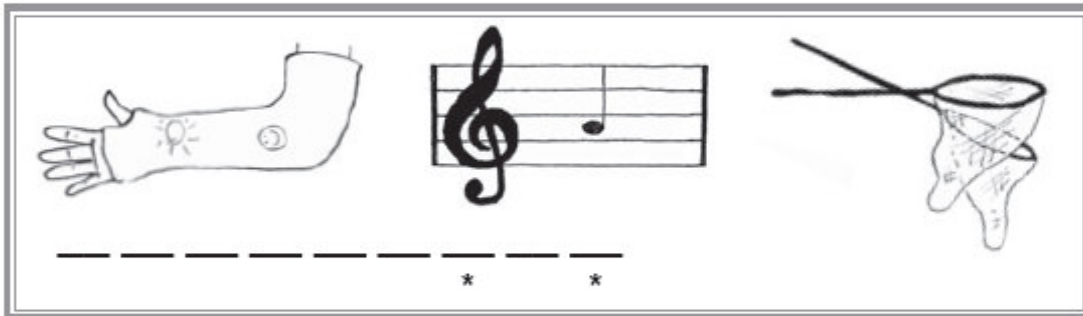

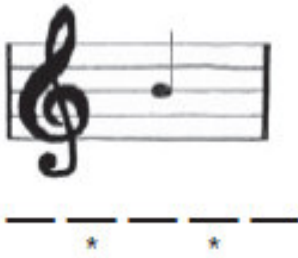

Arthur Mal
Gerard Jake
Candice Larry
Amanda Derek
Chase Kimberly
Zook Betty
Winston

@

1



& i



note after sol



E	RODED	RE
A	CASTANETS	ES
MIDDLE C	CATCHALL	CA
B	BONUS	OU
D	ATONED	TO
HIGH C	CANDIDATE	ND
G	BEEPING	IN
F	FLARING	NG

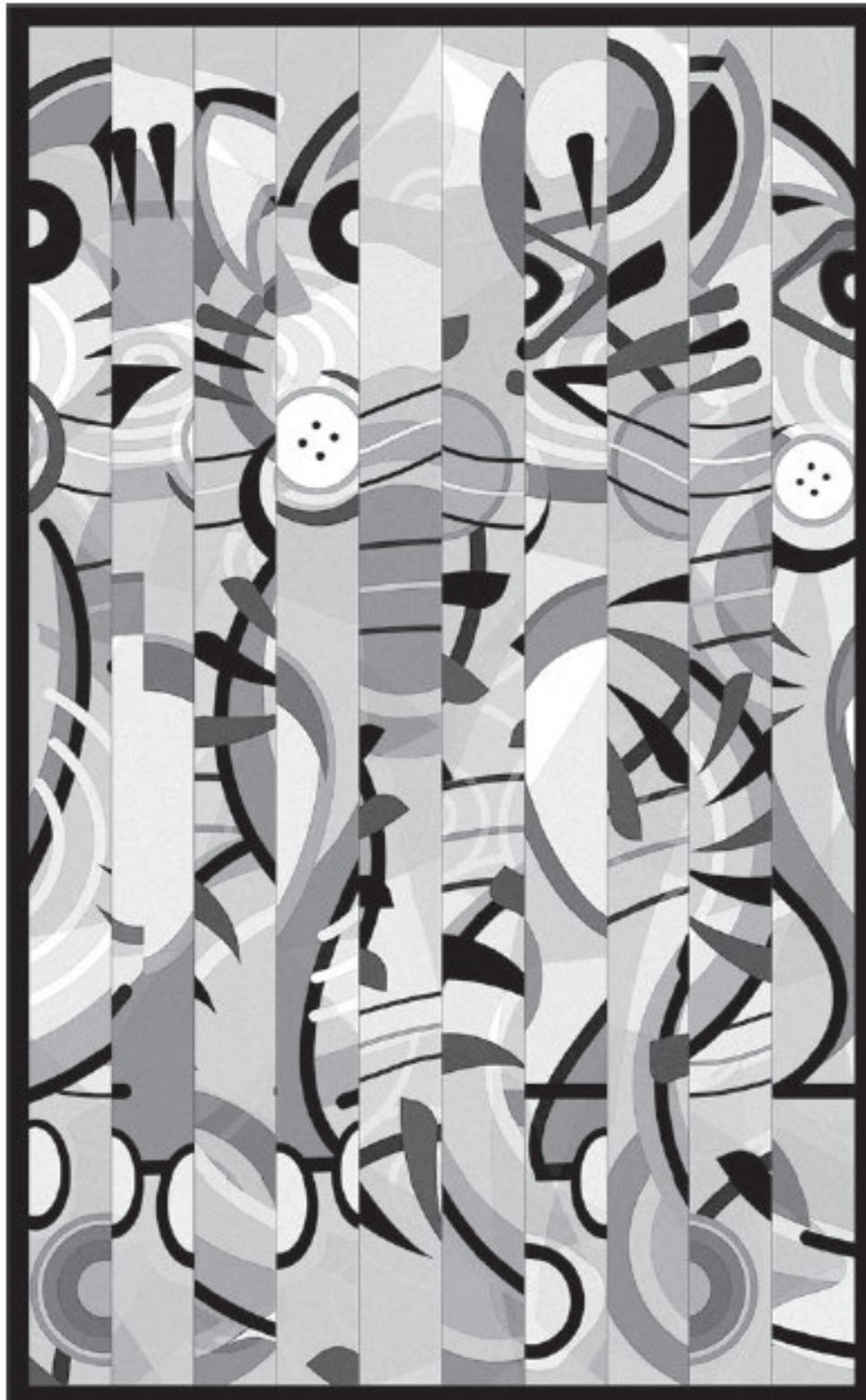

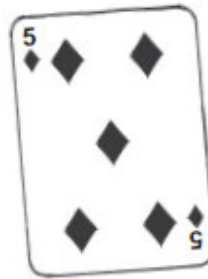
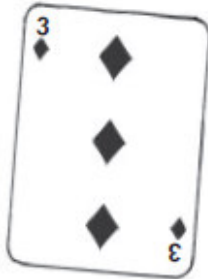
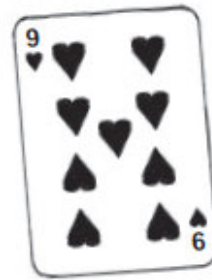
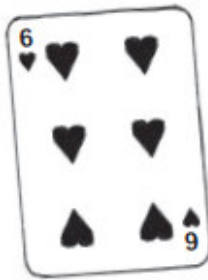
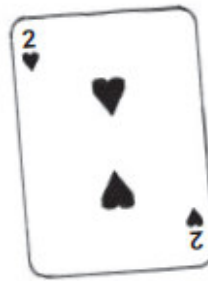
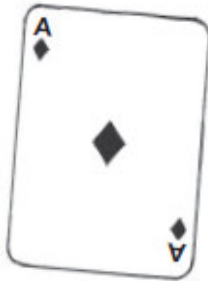
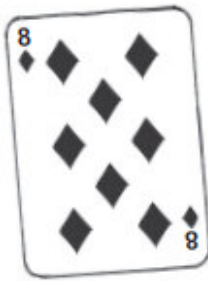

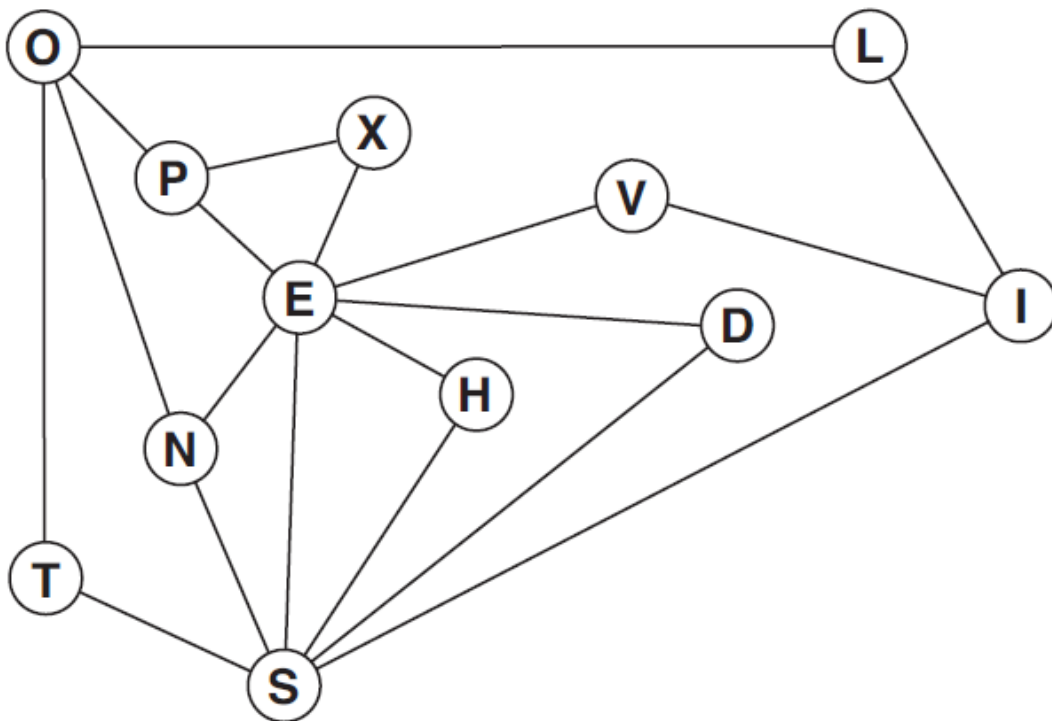
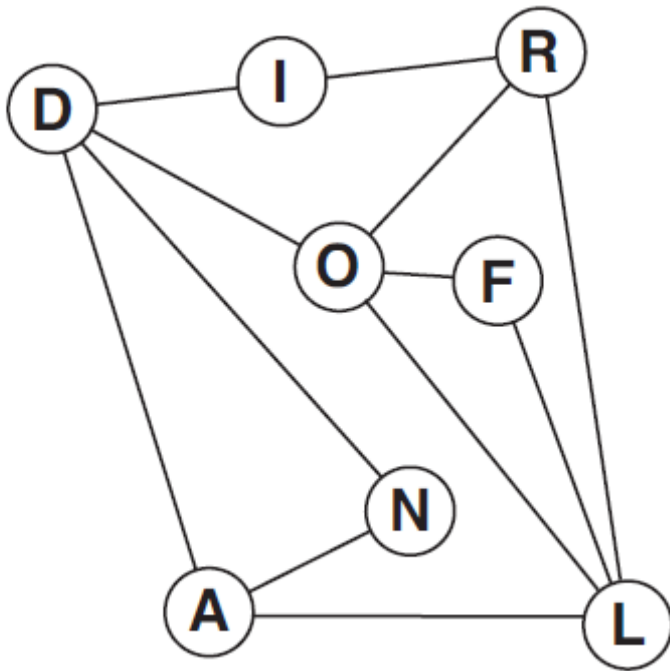

Page 114

1. Milk helps your bones grow, but I have to admit, soda is yummier.
2. Doris, Edward, and Eli, on their way to school, took a shortcut through the park.
3. After cleaning all the frying pans, your next task will be to scrub the stove.
4. Snaps, zippers, laces, or Velcro? Custom-made sneakers sure have a lot of options!
5. Once inside the cougar den, I awkwardly began taking pictures of the cubs.

Page 125

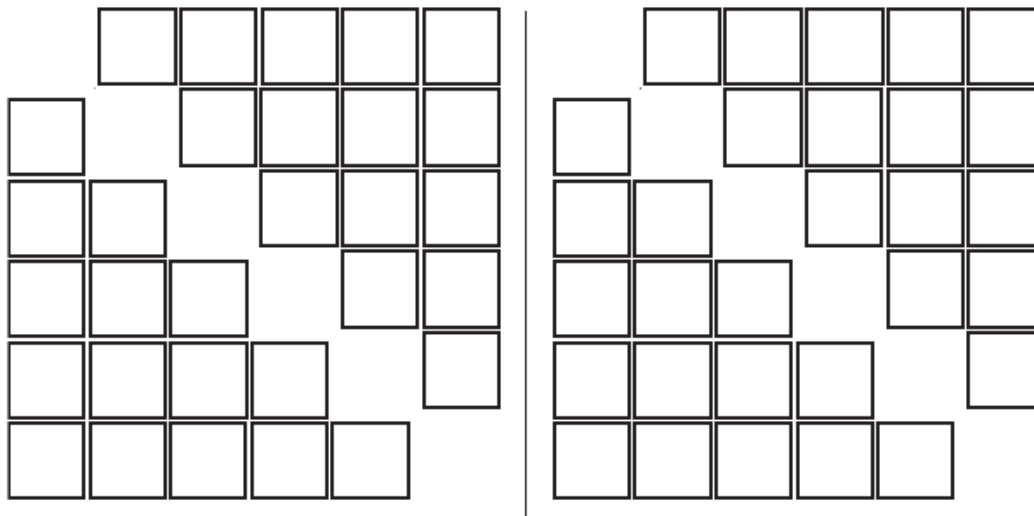

BANJO

GONG

ORGAN

TUBA

DRUM

HARP

PIANO

VIOLA

___ _ _ **BE** ___

Not as smart

C ___ _ **T** ___ _

Words under a picture, as in a newspaper

___ **U** ___ _ -**H** ___

Really enthusiastic

___ _ _ _ _ **LA**

Ingredient in many cereal bars

O ___ _ _ _ **N**

Child like Oliver Twist or Annie

___ _ **W** ___ _ _ **E**

The chin part of a skull

R ___ _ _ _ _ **I**

Italian food often stuffed with cheese

___ **E** ___ _ _ _ **Y**

Attractiveness

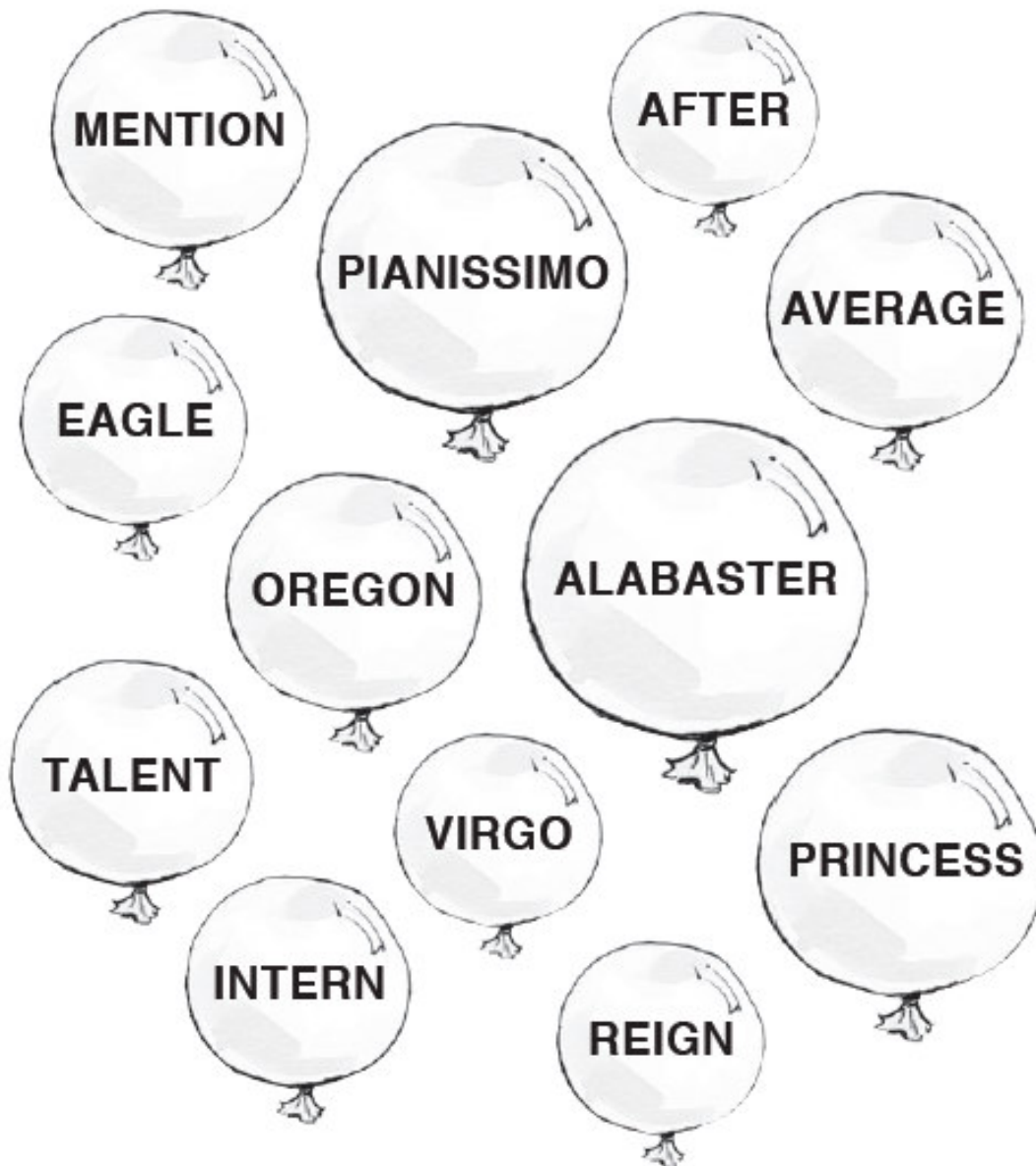

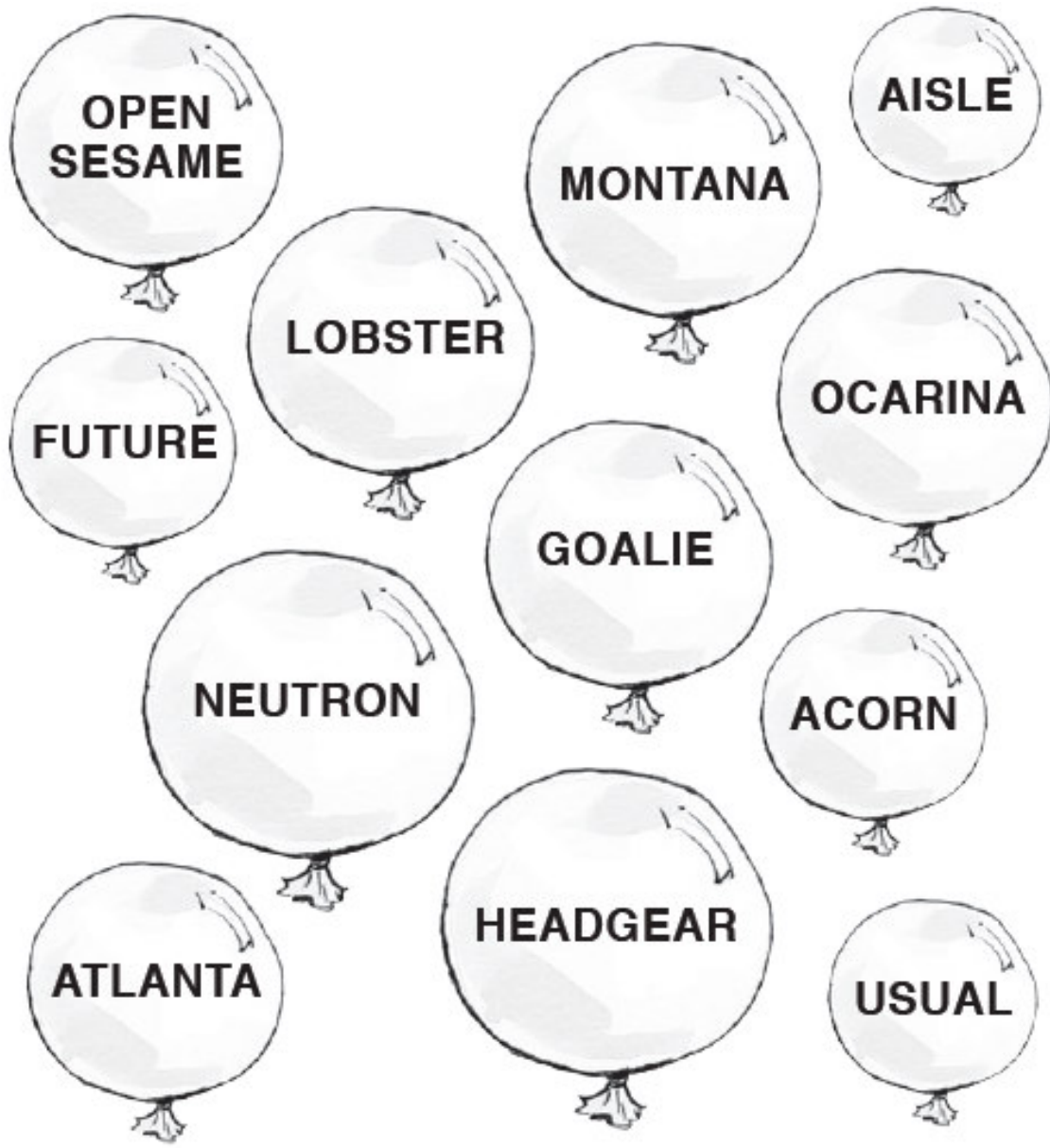

**OPEN
SESAME**

MONTANA

AISLE

LOBSTER

OCARINA

FUTURE

GOALIE

NEUTRON

ACORN

ATLANTA

HEADGEAR

USUAL

Page 142 – 143

<i>MENTION</i>	<i>EAGLE</i>
<i>AVERAGE</i>	<i>OREGON</i>
<i>PIANISSIMO</i>	<i>PRINCESS</i>
<i>AFTER</i>	<i>TALENT</i>
<i>GOALIE</i>	<i>INTERN</i>
<i>VIRGO</i>	<i>MONTANA</i>
<i>OPEN SESAME</i>	<i>REIGN</i>
<i>LOBSTER</i>	<i>AISLE</i>
<i>ATLANTA</i>	<i>OCARINA</i>
<i>NEUTRON</i>	<i>USUAL</i>
<i>HEADGEAR</i>	<i>ACORN</i>
<i>FUTURE</i>	<i>ALABASTER</i>

Page 166 – 167

<i>4 paces west</i>	<i>2 paces east</i>
<i>4 paces north</i>	<i>2 paces west</i>
<i>2 paces east</i>	<i>4 paces south</i>
<i>2 paces west</i>	<i>7 paces east</i>
<i>4 paces north</i>	<i>8 paces north</i>
<i>4 paces east</i>	<i>8 paces southeast</i>
<i>8 paces southeast</i>	<i>8 paces north</i>
<i>8 paces northeast</i>	<i>10 paces east</i>
<i>6 paces east</i>	<i>4 paces west</i>
<i>5 paces west</i>	<i>8 paces south</i>
<i>4 paces south</i>	

Page 179

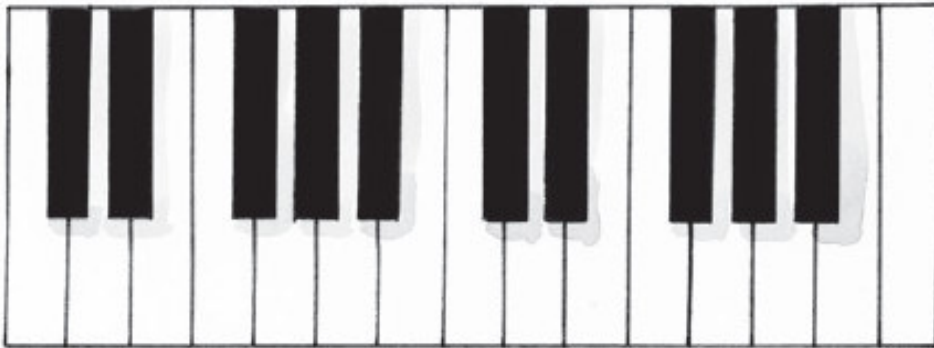

Page 222

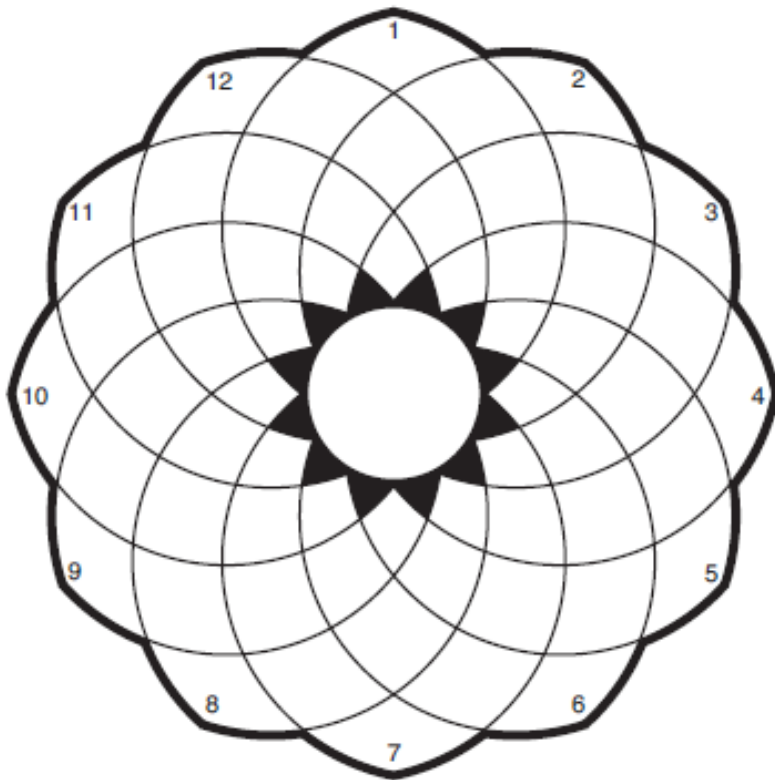

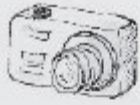

13 7 19



1 20



14 17



12 6 18



5 3



15 11



16 2 9



8 10



4

- Add an R to the end of the object.
- Add an R somewhere in the middle of the object.
- Add a W to the start of the object.
- Replace the first three letters with a Y.
- Remove the last two letters and spell what remains backward.
- Change the second letter to an O and spell backward.
- Replace the last two letters with an L.
- Change the last letter to a B and spell backward.
- Change the third letter to a G.

1 2 3 4

5 6 7 8

9 10 11 12

13 14 15 16

17 18 19 20

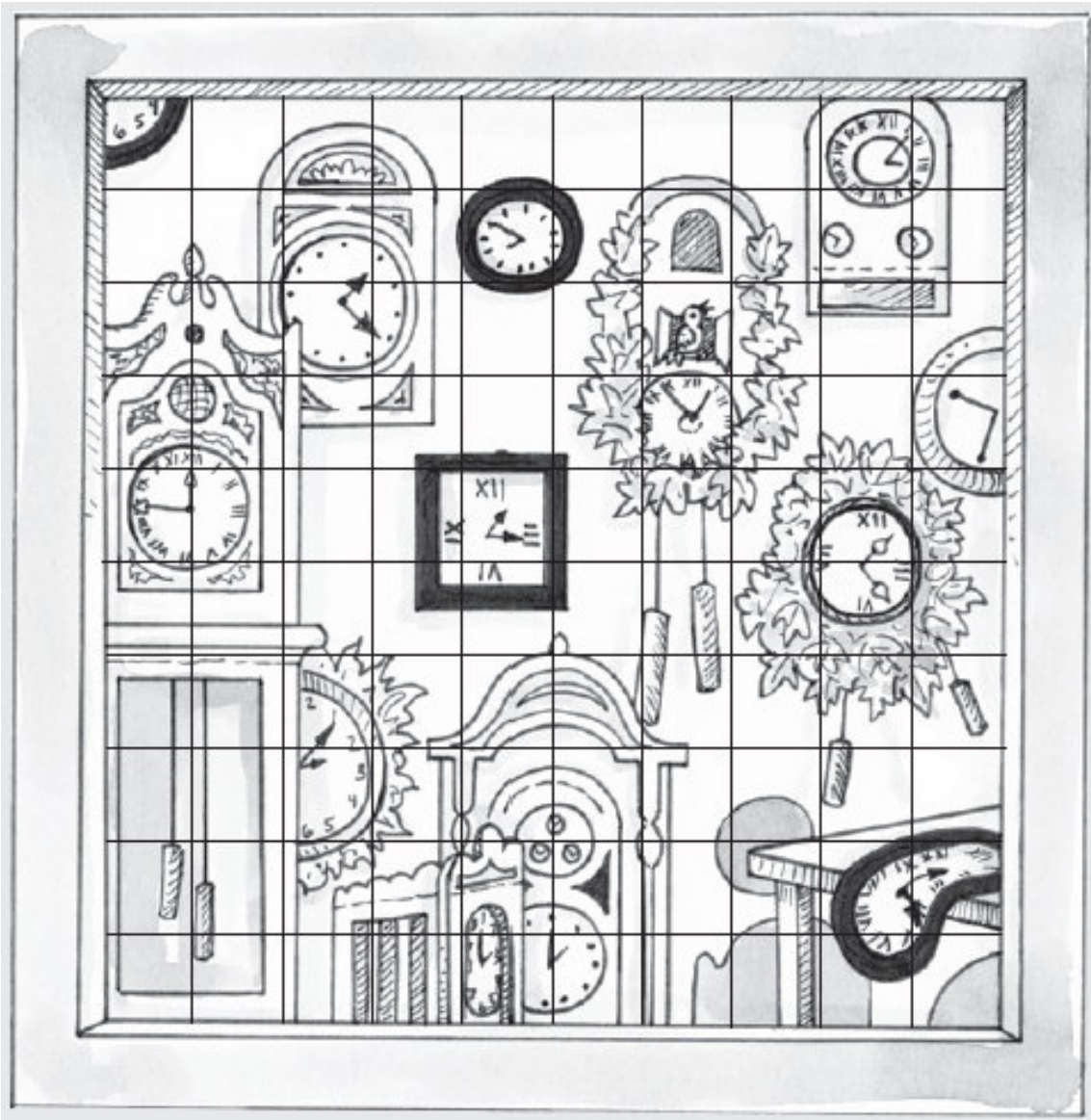

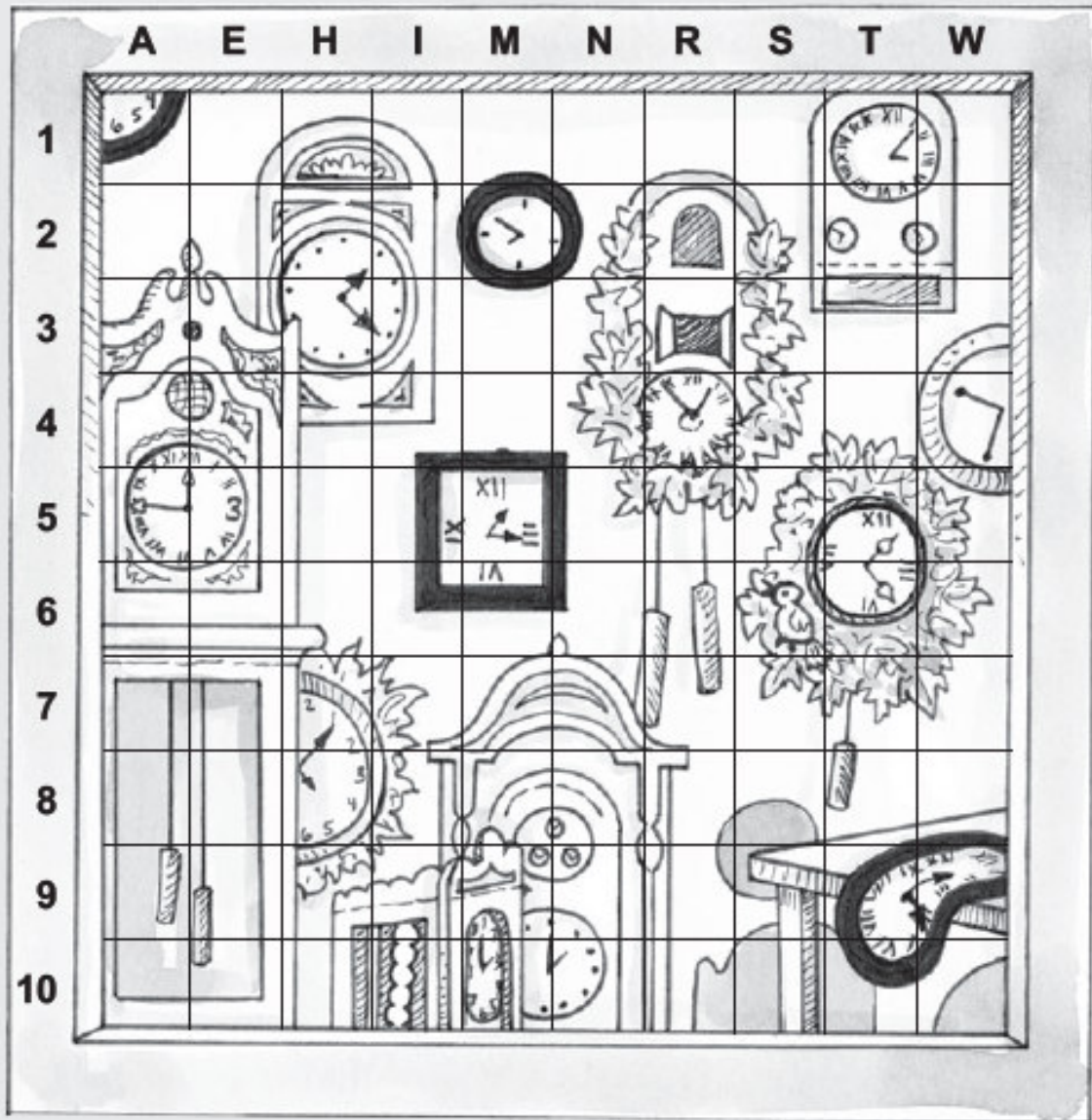

1 8 5 4 9 6 7 5 3 10 6 1 10 2 5

Page 233

1.
SICKS TEAM INN HITS
EWE WRY TON DEB LAG BORED WIDTH HISS

2.
SILL FUR WHERE WIDTH ABLE AID
CULL LORE HUFF ATE HUM HAY TOE

3.
WAR TURF RUM THUS GUY
POSE DITCH SHAWN ANON FELL HOPE

4.
OUGHT TOME MOPE EEL
LIT HULL FEE MAIL

Page 234

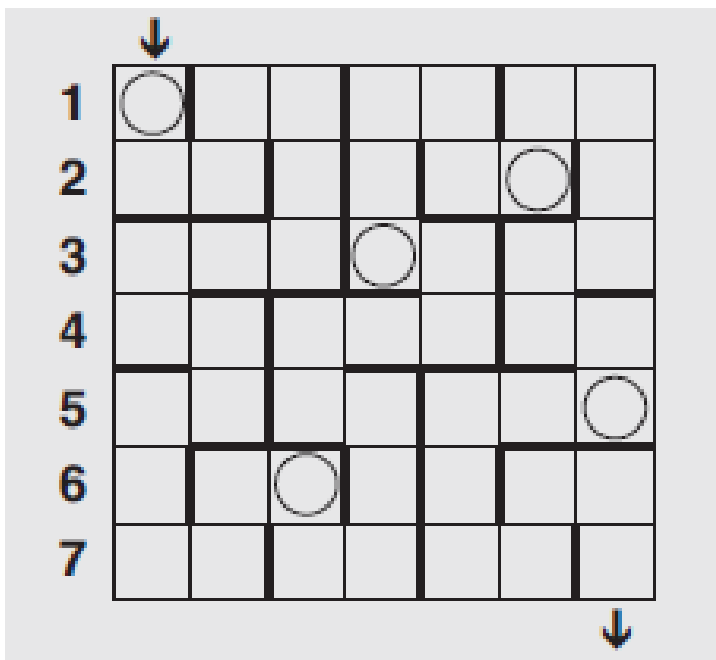

1. Most people believe that I'm _____
And on many a _____ I'm found.
But here's an odd fact I will _____:
_____ believe I am _____!

2. Pull a _____ 'cross a string
And I'm happy to _____.
(A hint for this _____:
I'm just like a _____.)

3. Take one _____ of _____.
And turn up the heat.
Soon I'm _____ instead
And _____ to eat.

4. If the _____ is out,
Just light up my _____.
And before you can pout,
it's _____ again _____!

BOW
BOXERS
BREAD
BRIGHT
CRUNCHY
DELICIOUS
FIDDLE
FINGER
POWER
QUICK
RIDDLE
ROUND
SHARE
SING
SLICE
SQUARE
WICK

